

## Surface Mount Super Fast Recovery Rectifier

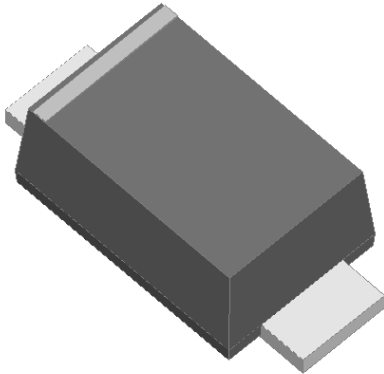

### Features

- Low profile package
- Ideal for automated placement
- Glass passivated chip junction
- Super fast switching for high efficiency
- High forward surge capability
- Meets MSL level 1, per J-STD-020, LF maximum peak of 260 °C

### Typical Applications

For use in super fast switching rectification of power supply, inverters, converters, and freewheeling diodes for consumer and telecommunication.

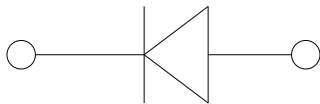

### Mechanical Date

- **Package:** SOD-123FL  
Molding compound meets UL 94 V-0 flammability rating, RoHS-compliant, halogen-free
- **Terminals:** Tin plated leads, solderable per J-STD-002 and JESD22-B102
- **Polarity:** Cathode line denotes the cathode end

### ■ Maximum Ratings (T<sub>a</sub>=25°C Unless otherwise specified)

PARAMETER	SYMBOL	UNIT	E15A	E15B	E15C	E15D	E15F	E15G	E15H	E15J
Device marking code			E15A	E15B	E15C	E15D	E15F	E15G	E15H	E15J
Maximum Repetitive Peak Reverse Voltage	VRRM	V	50	100	150	200	300	400	500	600
Maximum RMS Voltage	VRMS	V	35	70	105	140	210	280	350	420
Maximum DC blocking Voltage	VDC	V	50	100	150	200	300	400	500	600
Average rectified output current @60Hz sine wave, Resistance load, TL (FIG.1)	I <sub>o</sub>	A	1.5							
Forward Surge Current (Non-repetitive) @60Hz Half-sine wave, 1 cycle, T <sub>j</sub> =25°C	I <sub>FSM</sub>	A	45							
Forward Surge Current (Non-repetitive) @1ms, square wave, 1 cycle, T <sub>j</sub> =25°C			90							
Current squared time @1ms≤t≤8.3ms T <sub>j</sub> =25°C	I <sup>2</sup> t	A <sup>2</sup> s	8.4							
Storage temperature	T <sub>stg</sub>	°C	-55 ~ +150							
Junction temperature	T <sub>j</sub>	°C	-55 ~ +150							

### ■ Electrical Characteristics (T<sub>a</sub>=25°C Unless otherwise specified)

PARAMETER	SYMBOL	UNIT	TEST CONDITIONS	E15A	E15B	E15C	E15D	E15F	E15G	E15H	E15J
Maximum instantaneous forward voltage	V <sub>F</sub>	V	I <sub>FM</sub> =1.5A	1.0			1.3		1.7		
Maximum reverse recovery time	t <sub>r</sub>	ns	I <sub>F</sub> =0.5A, I <sub>R</sub> =1.0A, I <sub>r</sub> =0.25A	35							
Maximum DC reverse current at rated DC blocking voltage	I <sub>R</sub>	μA	T <sub>j</sub> =25°C	5							
			T <sub>j</sub> =125°C	100							
Typical junction capacitance	C <sub>j</sub>	pF	Measured at 1MHz and Applied Reverse Voltage of 4.0 V.D.C	23			15		10		



# E15A THRU E15J

## ■ Thermal Characteristics (T<sub>a</sub>=25°C Unless otherwise specified)

PARAMETER	SYMBOL	UNIT	E15A	E15B	E15C	E15D	E15F	E15G	E15H	E15J
Typical Thermal resistance	R <sub>θJ-A</sub> <sup>(1)</sup>	°C/W	68							
	R <sub>θJ-L</sub> <sup>(1)</sup>		20							
	R <sub>θJ-C</sub> <sup>(1)</sup>		18							

Note:  
 (1) Thermal resistance between junction and ambient and between junction and lead mounted on P.C.B with 3mm\*3mm copper pad areas.

## ■ Characteristics (Typical)

FIG1: I<sub>o</sub>-T<sub>L</sub> Curve

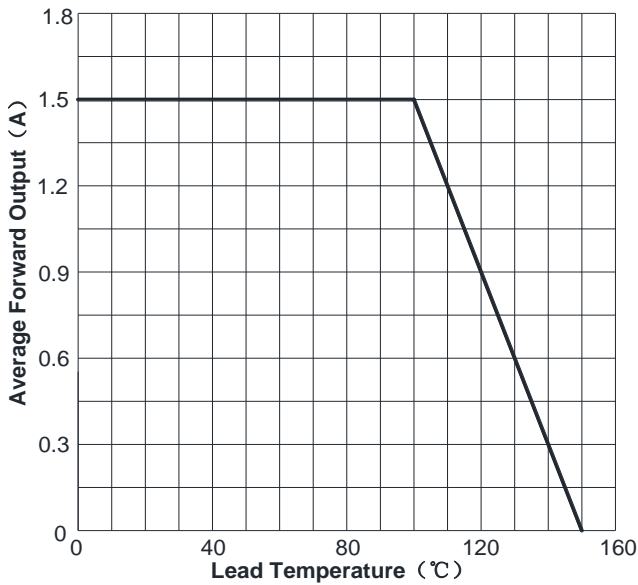

FIG2: Surge Forward Current Capability

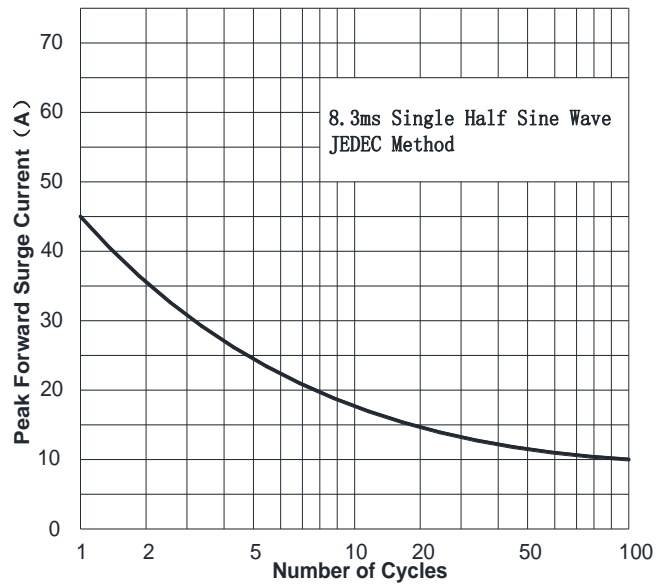

FIG3: Typical Forward Voltage

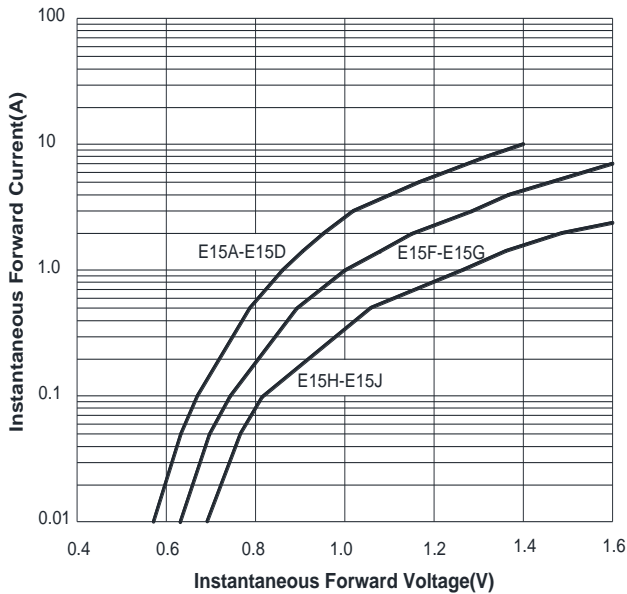

FIG4: Typical Reverse Characteristics

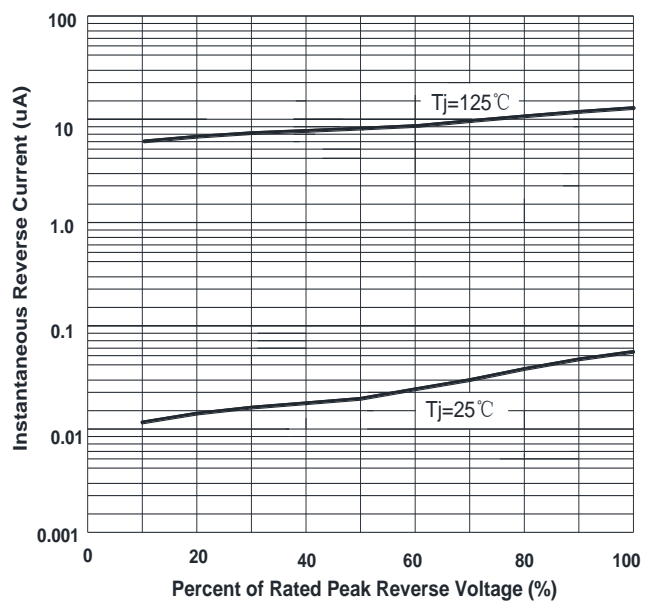
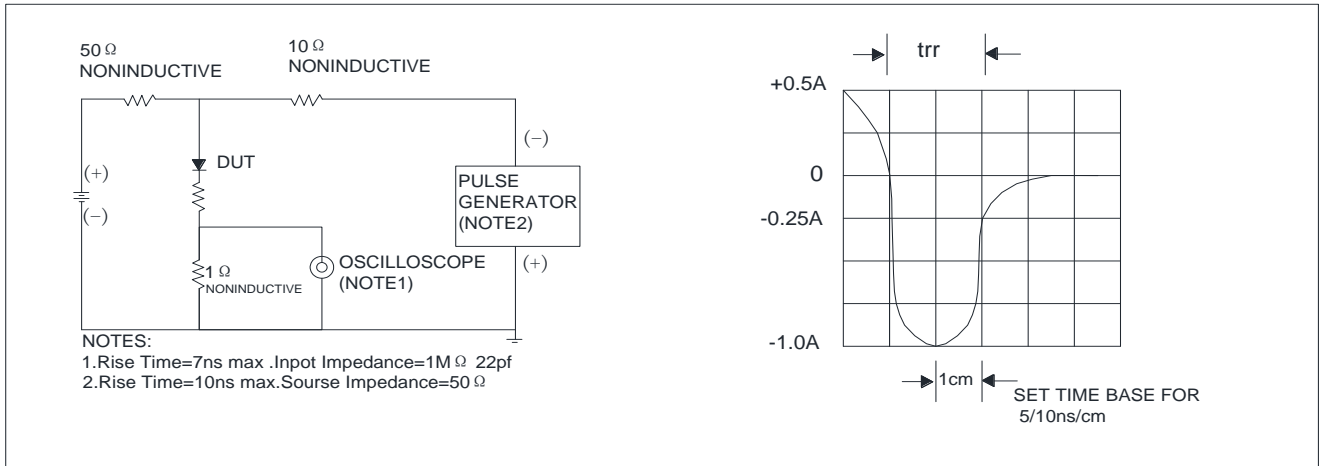

FIG.5: Diagram of circuit and Testing wave form of reverse recovery time



## Ordering Information (Example)

PREFERED P/N	PACKING CODE	UNIT WEIGHT(g)	MINIMUM PACKAGE(pcs)	INNER BOX QUANTITY(pcs)	OUTER CARTON QUANTITY(pcs)	DELIVERY MODE
E15A THRU E15J	F1	Approximate 0.0169	3000	30000	120000	7" reel
E15A THRU E15J	F2	Approximate 0.0169	2500	25000	100000	7" reel
E15A THRU E15J	F3	Approximate 0.0169	10000	/	210000	13" reel
E15A THRU E15J	F4	Approximate 0.0169	3000	54000	108000	7" reel
E15A THRU E15J	F5	Approximate 0.0169	10000	/	160000	13" reel
E15A THRU E15J	F6	Approximate 0.0169	3000	12000	60000	7" reel

## Outline Dimensions

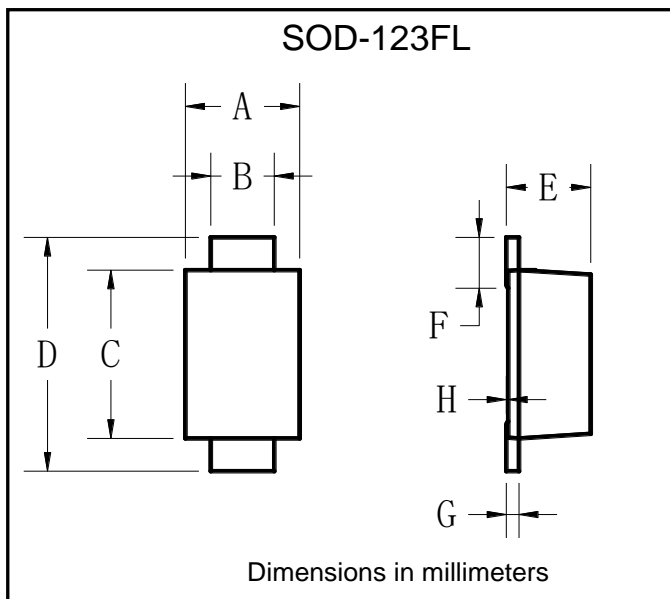

SOD-123FL		
Dim	Min	Max
A	1.60	1.90
B	0.90	1.10
C	2.55	2.85
D	3.60	3.90
E	1.00	1.20
F	0.40	0.90
G	0.10	0.25
H	0.00	0.05



## E15A THRU E15J

### ■ Suggested pad layout

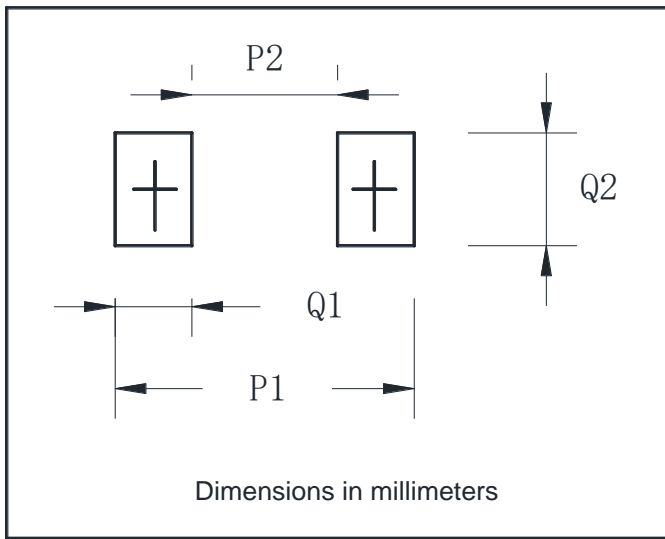

SOD-123FL	
Dim	Millimeters
P1	3.90
P2	1.90
Q1	1.00
Q2	1.50



## E15A THRU E15J

---

### Disclaimer

The information presented in this document is for reference only. Yangzhou Yangjie Electronic Technology Co., Ltd. reserves the right to make changes without notice for the specification of the products displayed herein to improve reliability, function or design or otherwise.

The product listed herein is designed to be used with ordinary electronic equipment or devices, and not designed to be used with equipment or devices which require high level of reliability and the malfunction of which would directly endanger human life (such as medical instruments, transportation equipment, aerospace machinery, nuclear-reactor controllers, fuel controllers and other safety devices), Yangjie or anyone on its behalf, assumes no responsibility or liability for any damages resulting from such improper use of sale.

This publication supersedes & replaces all information previously supplied. For additional information, please visit our website [http:// www.21yangjie.com](http://www.21yangjie.com) , or consult your nearest Yangjie's sales office for further assistance.